

United States of America
Department of Transportation -- Federal Aviation Administration
Supplemental Type Certificate

Number SA1074GL

This certificate issued to Aero Cables Corp.
11953 S. Spaulding School Road
Unit 2
Plainfield, IL 60544

certifies that the change in the type design for the following product with the limitations and conditions therefor as specified hereon meets the airworthiness requirements of Part 3 of the Civil Air Regulations.
(See Type Certificate Data Sheet 2A3 for complete certification basis.)

Original Product -- Type Certificate Number : 2A3
Make : Mooney Airplane Company, Inc.
Model : M20E, M20F, M20J, M20K

Description of Type Design Change:

Installation of a Cooling Shroud on engine driven dry air pumps in accordance with S & M Products Report No. 10, revision 00 dated August 28, 1986, or other FAA approved revision.

Limitations and Conditions :

- 1) Compatibility of this design change with previously approved modifications must be determined by the installer.
- 2) If the holder agrees to permit another person to use this certificate to alter the product, the holder shall give the other person written evidence of that permission

This certificate and the supporting data which is the basis for approval shall remain in effect until surrendered, suspended, revoked or a termination date is otherwise established by the Administrator of the Federal Aviation Administration.

Date of application : August 28, 1986

Date reissued : March 19, 2004; June 15, 2004

Date of issuance : October 9, 1986

Date amended :

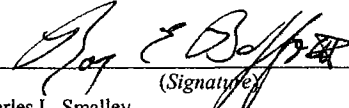

By direction of the Administrator

for 
(Signature)
Charles L. Smalley
Manager, Systems and Flight Test Branch
Chicago Aircraft Certification Office

(Title)

S&M Report No. 10
Revision 00
August 28, 1986

- KIT NO. 10 - Vacuum Pump Cooling Kit for Airborne Model 200 thru 212CW and CC Dry Air Pumps
KIT NO. 11 - Vacuum Pump Cooling Kit for EDO-AIRE Model 1U128, 1U128A and 1U128B; and SIGMA TEK Model 1U128B Dry Air Pumps
KIT NO. 20 - Vacuum Pump Cooling Kit for Airborne Model 400-Series Dry Air Pumps

MOONEY M20E, M20F, M20J, M20K TC 2A3

REVISION PAGE

<u>Table of Contents</u>	<u>Page No.</u>	<u>Revision/Date</u>
Revision Page	1	00, 08-28-86
Kits No. 10, 11, and 20 Parts Lists	2	00, 08-28-86
Drawing List for Kits No. 10, 11, and 20	3	00, 08-28-86
Installation Instructions for Kits No. 10 and 11	4 & 5	00, 08-28-86
Installation Instructions for Kit No. 20	6 & 7	00, 08-28-86
STC and Eligibility Listing	8	00, 08-28-86
Drawing U (Mooney M20E, M20F)	9	00, 08-28-86
Drawing V (Mooney M20J (201))	9	00, 08-28-86
Drawing W (Mooney M20K (231))	9	00, 08-28-86
Drawing 1 (View of Cooling Kit No. 10)	10	00, 08-28-86
Drawing 2 (View of Cooling Kit No. 11)	11	00, 08-28-86
Drawing 3 (View of Cooling Kit No. 20)	12	00, 08-28-86
Material Specifications	13a & b	00, 08-28-86
Drawing, Cooling Shroud Model 2CDH	14	00, 08-28-86
Drawing, Cooling Shroud Model 4ADH	15	00, 08-28-86
Drawing, Cooling Shroud Model 6ADH	16	00, 08-28-86

FAA
APPROVED

OCT 09 1986

CHICAGO AIRCRAFT
CERTIFICATION OFFICE
CENTRAL REGION
ACE-136C
MUCD

Handwritten initials/signature

S&M Report No. 10
Revision 00
August 28, 1986

KIT NO. 10 - Vacuum Pump Cooling Kit for Airborne Model 200 thru 212CW and CC Dry Air Pumps

KIT NO. 11 - Vacuum Pump Cooling Kit for EDO-AIRE Model 1U128, 1U128A and 1U128B; and SIGMA TEK Model 1U128B Dry Air Pumps

KIT NO. 20 - Vacuum Pump Cooling Kit for Airborne Model 400-Series Dry Air Pumps

MOONEY M20E, M20F, M20J, M20K TC 2A3

KIT NO. 10 PARTS LIST - AIRBORNE 200-212CW & CC INSTALLATION

<u>Quantity</u>	<u>Part No.</u>	<u>Description</u>
1	2CDH	Cooling Shroud
1	2CDH-1	Flange
1	2CDH-2	Approx 13.3" C.A.T. Aeroduct Tubing
2	2CDH-3	Cable Ties
1	Rev. 00, 08-28-86	Installation Instructions
1	Rev. 00, 08-28-86	Flange Installation Drawings
1	Rev. 00, 08-28-86	Kit Installation Drawing (View of Cooling Kit on Pump)
1	Rev. 00, 08-28-86	STC and Eligibility Listing

KIT NO. 11 PARTS LIST - EDO-AIRE & SIGMA TEK INSTALLATION

<u>Quantity</u>	<u>Part No.</u>	<u>Description</u>
1	4ADH	Cooling Shroud
1	2CDH-1	Flange
1	2CDH-2	Approx 17" C.A.T. Aeroduct Tubing
2	2CDH-3	Cable Ties
1	Rev. 00, 08-28-86	Installation Instructions
1	Rev. 00, 08-28-86	Flange Installation Drawings
1	Rev. 00, 08-28-86	Kit Installation Drawing (View of Cooling Kit on Pump)
1	Rev. 00, 08-28-86	STC and Eligibility Listing

KIT NO. 20 PARTS LIST - AIRBORNE 400-SERIES INSTALLATION

<u>Quantity</u>	<u>Part No.</u>	<u>Description</u>
1	6ADH	Cooling Shroud
1	6ADH-1	Flange
1	6ADH-2	Approx 17" C.A.T. Aeroduct Tubing
2	2CDH-3	Cable Ties
1	Rev. 00, 08-28-86	Installation Instructions
1	Rev. 00, 08-28-86	Flange Installation Drawings
1	Rev. 00, 08-28-86	Kit Installation Drawing (View of Cooling Kit on Pump)
1	Rev. 00, 08-28-86	STC and Eligibility Listing

FAA
APPROVED
OCT 09 1986
CHICAGO AIRCRAFT
CERTIFICATION OFFICE
CENTRAL REGION
ACE 130c
MWD

S&M Report No. 10
Revision 00
August 28, 1986

KIT NO. 10 - Vacuum Pump Cooling Kit for Airborne Model 200 thru 212CW and CC Dry Air Pumps

KIT NO. 11 - Vacuum Pump Cooling Kit for EDO-AIRE Model 1U128, 1U128A and 1U128B; and SIGMA TEK Model 1U128B Dry Air Pumps

KIT NO. 20 - Vacuum Pump Cooling Kit for Airborne Model 400-Series Dry Air Pumps

MOONEY M20E, M20F, M20J, M20K TC 2A3

DRAWING LIST FOR KITS NO. 10, 11, and 20

<u>Drawing</u>	<u>Description</u>	<u>Page No.</u>
U	MOONEY M20E, M20F	9
V	MOONEY M20J (201)	9
W	MOONEY M20K (231)	9
1	KIT NO. 10 - View of Cooling Shroud on Airborne 200-212CW and CC Pumps, Ducting and Flange	10
2	KIT NO. 11 - View of Cooling Shroud on EDO-AIRE and SIGMA TEK Pumps, Ducting and Flange	11
3	KIT NO. 20 - View of Cooling Shroud on Airborne 400-Series Pumps, Ducting and Flange	12

S&M Report No. 10
Revision 00
August 28, 1986

KIT NO. 10 - Vacuum Pump Cooling Kit for Airborne Model 200 thru 212CW and CC Dry Air Pumps

KIT NO. 11 - Vacuum Pump Cooling Kit for EDO-AIRE Model 1U128, 1U128A and 1U128B; and SIGMA TEK Model 1U128B Dry Air Pumps

MOONEY M20E, M20F, M20J, M20K TC 2A3

INSTALLATION INSTRUCTIONS

1. To install Vacuum Pump Cooling Kit No. 10 on Airborne Model 200 thru 212CW and CC Dry Air Pumps, or Vacuum Pump Cooling Kit No. 11 on EDO-AIRE Model 1U128, 1U128A, 1U128B, and SIGMA TEK Model 1U128B Dry Air Pumps installed on the aircraft shown above, proceed according to the following instructions and refer to Flange Installation Drawings U, V, and W. For a view of the cooling shroud, ducting and flange, refer to Drawing 1 for Kit No. 10 and Drawing 2 for Kit No. 11.

2. COOLING SHROUD INSTALLATION.

a. To mount the cooling shroud on the vacuum pump, the shroud must be held open slightly while installing. The shroud is made so the cooling exit is not centered with the cooling inlet. Turn over and/or rotate the shroud on the vacuum pump to best compromise the cooling inlet and outlet with other objects that may interfere with them near and around the vacuum pump.

b. On the Airborne installation (Kit No. 10), the shroud may not be able to be slipped on the pump and rotated to the desired position because of interference with other parts. In this case, remove the rear fitting on the pump, slip the shroud on and rotate it, then reinstall the rear fitting. If lubrication of the fitting is needed, use only a spray silicone on the threads, shake off the excess and let it dry before installing the fitting. **DO NOT** use oil, grease or tape on the threads.

c. Optional Shroud Position on Lycoming Engines. Due to tachometer drive interference on some Lycoming engines, an optional position on the shroud may be 1/8" toward the undriven end of the pump, or the shroud can be filed to allow the shroud to center on the pump. **DO NOT** file through the shroud.

3. COOLING DUCT INSTALLATION. Install the cooling duct on the shroud inlet using sealant and a nylon cable tie, as per instructions on Drawing 1 or 2, as applicable. Route the cooling duct to the aft side of the rear engine baffle, avoiding sharp bends, sharp objects and moving parts. Do not cut off excess duct at this time.

4. INSTALLATION OF FLANGE FITTING. (Refer to Drawings U, V, or W)

a. Make a 1 1/8" hole in the baffle, maintaining a 1" edge distance minimum, or as per drawing.

b. Drill four (4) #40 holes and use washers under rivets on flange side. Install the flange through the baffle from the front. Use sealant between flange and baffle. Install the flanged fitting using four (4) AN470AD-3 rivets or drill four (4) #28 holes and use four (4) AN526-632 screws and AN365-632 nuts and AN960-6 washers.

S&M Report No. 10
Revision 00
August 28, 1986

Installation Instructions (Continued):

c. Cut the cooling duct to length--avoid making it too long or too short for best routing. Try to avoid making over 90 degree bends and sharp bends.

d. Install the cooling duct on the flanged fitting using sealant and a nylon cable tie (see Drawing 1 or 2). Support or tie the cooling duct every 12 inches.

5. SEALING REQUIREMENTS.

a. To compensate for the 7/8" hole in the rear engine baffle, seal holes in the engine baffling at forward and rear corners, the space between the rear baffle and the engine crankcase, where sheet metal corners have holes in them, and where hoses and wires pass through the baffling. Seal enough holes and gaps to exceed .601 square inch, or 1/8" x 5", or 1/4" x 2.5".

b. Use 890 or RTV 106 red high temperature sealants per manufacturers' instructions. Alternate sealants are GE RTV 102, 103, 108, 158; Dow Corning 732 RTV sealants; or equivalents.

6. PAPERWORK.

a. Add the appropriate cooling kit number to the aircraft equipment list.

b. Weight of this kit is .24 lbs.

c. Complete FAA Form 337 and make proper logbook entry of kit installation.

d. These installation instructions will become part of the permanent aircraft records.

KIT NO. 20 - Vacuum Pump Cooling Kit for Airborne Model 400-Series Dry Air Pumps

MOONEY M20E, M20F, M20J, M20K TC2A3

INSTALLATION INSTRUCTIONS

(Note: Cooling Shroud must be at least 72° F. before attempting to install.)

1. To install Vacuum Pump Cooling Kit No. 20 on Airborne Model 400-Series Dry Air Pumps installed on the aircraft shown above, proceed according to the following instructions and refer to Flange Installation Drawings U, V, and W. For a view of the cooling shroud, ducting and flange, refer to Drawing 3.
2. COOLING SHROUD INSTALLATION. To mount the cooling shroud on the vacuum pump, the shroud must be pushed on over the fins on the pump. If unable to do so, heat the shroud under hot tap water or allow it to set in hot water for five minutes. (Caution: Water should not be hot enough to burn yourself.) The shroud is made so the cooling exit is not centered with the cooling inlet. Turn over and/or rotate the shroud on the vacuum pump to best compromise the cooling inlet and outlet with other objects that may interfere with them near and around the vacuum pump. If a fitting or fittings are removed from the pump during installation, and lubrication is needed, use only a spray silicone on the threads, shake off the excess and let it dry before installing the fitting. **DO NOT** use oil, grease or tape on the threads.
3. COOLING DUCT INSTALLATION. Install the cooling duct on the shroud inlet using sealant and a nylon cable tie, as per instructions on Drawing 3. Route the cooling duct to the aft side of the rear engine baffle, avoiding sharp bends, sharp objects and moving parts. **DO NOT** cut off excess duct at this time.
4. INSTALLATION OF FLANGE FITTING. (Refer to Drawings U, V, or W)
 - a. Make a 1 3/8" hole in the baffle, maintaining a 1" edge distance minimum, or as per drawing.
 - b. Drill four (4) #40 holes and use washers under rivets on flange side. Install the flange through the baffle from the front. Use sealant between flange and baffle. Install the flanged fitting using four (4) AN470AD-3 rivets or drill four (4) #28 holes and use four (4) AN526-632 screws and AN365-632 nuts and AN960-6 washers.
 - c. Cut the cooling duct to length--avoid making it too long or too short for best routing. Try to avoid making over 90 degree bends and sharp bends.
 - d. Install the cooling duct on the flanged fitting using sealant and a nylon cable tie (see Drawing 3. Support or tie the cooling duct every 12 inches.
5. SEALING REQUIREMENTS.
 - a. To compensate for the 1.07" hole in the rear engine baffle, seal holes in the engine baffling at forward and rear corners, the space between the rear baffle and the engine crankcase, where sheet metal corners have holes in them, and where hoses and wires pass through the baffling. Seal enough holes and gaps to exceed .899 square inch, or 1/8" x 7.2", or 1/4" x 3.6".

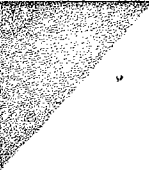

S&M Report No. 10
Revision 00
August 28, 1986

Installation Instructions for Kit No. 20 (Continued):

b. Use 890 or RTV 106 red high temperature sealants per manufacturers' instructions. Alternate sealants are GE RTV 102, 103, 108, 158; Dow Corning 732 RTV sealants; or equivalents.

6. PAPERWORK.

- a. Add the appropriate cooling kit number to the aircraft equipment list.
- b. Weight of this kit is .30 lbs.
- c. Complete FAA Form 337 and make proper logbook entry of kit installation.
- d. These installation instructions will become part of the permanent aircraft records.

S&M Report No. 10
Revision 00
August 28, 1986

- KIT NO. 10 - Vacuum Pump Cooling Kit for Airborne Model 200 thru 212CW and CC Dry Air Pumps
KIT NO. 11 - Vacuum Pump Cooling Kit for EDO-AIRE Model 1U128, 1U128A and 1U128B; and SIGMA TEK Model 1U128B Dry Air Pumps
KIT NO. 20 - Vacuum Pump Cooling Kit for Airborne Model 400-Series Dry Air Pumps

STC AND ELIGIBILITY LISTING

<u>Kit No.</u>	<u>TC No.</u>	<u>STC No.</u>	<u>Eligibility</u>
10 & 11	3A12	SA702GL	CESSNA 172K, 172L, 172M, 172N, 172P, 172Q
10 & 11	3A13	SA777GL	CESSNA 182G, 182H, 182J, 182K, 182L, 182M, 182N, 182P, 182Q, R182, TR182, T182
10, 11, 20	3A21	SA785GL	CESSNA 210L, 210M, 210N, T210L, T210M, T210N, 210R, T210R, P210N, P210R
10 & 11	3A19	SA1003GL	CESSNA 152 and A152
10 & 11	A4CE	SA791GL	CESSNA 206, P206, P206A, P206B, P206C, P206D, P206E, U206, U206A, U206B, U206C, U206D, U206E, U206F, U206G, TP206A, TP206B, TP206C, TP206D, TP206E, TU206A, TU206B, TU206C, TU206D, TU206E, TU206F, TU206G
10, 11, 20	A7SO	SA1015GL	PIPER PA 34-200T, PA 34-220T
10, 11, 20	3A15	SA1034GL	BEECH F33A, S35, V35, V35A, V35B, 36, A36, A36TC, B36TC
10, 11, 20	2A3	Pending	MOONEY M20E, M20F, M20J, M20K
10 & 11	2A13	Pending	PIPER PA-28-140, PA-28-150, PA-28-160, PA-28-180, PA-28-235, PA-28S-235, PA-28S-160, PA-28S-180, PA-28R-180, PA-28R-200, PA-28-151, PA-28-181, PA-28-161, PA-28R-201, PA-28R-201T, PA-28-236, PA-28RT-201, PA-28RT-201T, PA-28-201T
10, 11, 20	A3SO	Pending	PA-32-260, PA-32-300, PA-32S-300, PA-32R-300, PA-32RT-300, PA-32R-301, PA-32-301

S&M Report No. 10
Revision 00
August 28, 1986

MOONEY M20E, M20F TC 2A3

1 1/8" hole, centered as shown

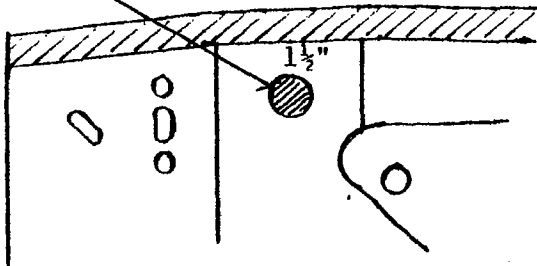

View: R H rear engine baffle,
looking aft

DRAWING U

MOONEY M20J (201) TC 2A3

1 1/8" hole

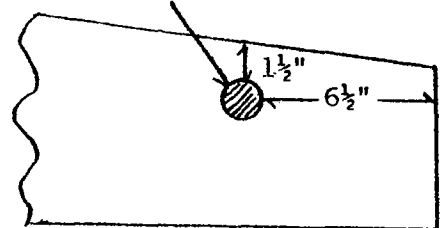

View: R H rear engine baffle,
looking forward

DRAWING V

MOONEY M20K (231) TC 2A3

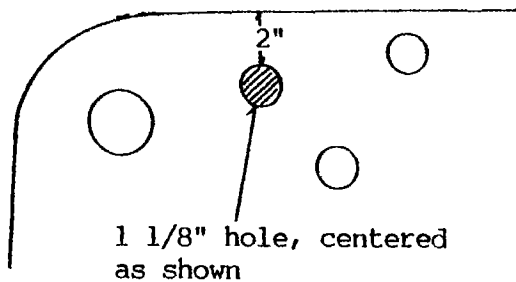

View: L H rear engine baffle,
looking forward

DRAWING W

KIT NO. 10

VIEW OF COOLING SHROUD ON AIRBORNE 200-212CW & CC PUMPS, DUCTING & FLANGE

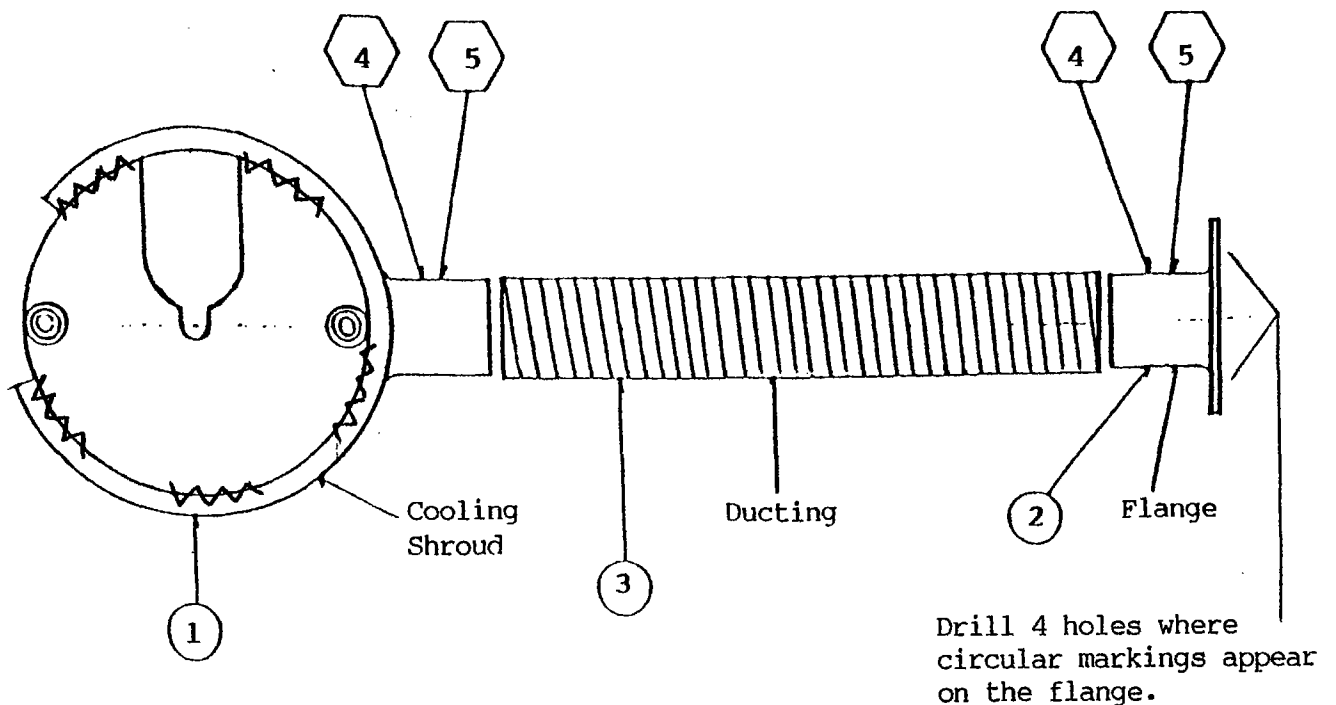

Note: Shroud must be centered on the pump.

4 Cable Ties - Attach these around ducting at inlet of shroud and outlet of flange after ducting has been sealed into place on the inlet and outlet.

5 Sealant - Place sealant on outside of shroud inlet and flange outlet, then push ducting into place. For type of sealant to be used, refer to paragraph 5b of Installation Instructions. Note: If cooling shroud appears to rotate easily after installation, it may be advisable to place a sealant fillet between shroud and pump as shown.

DRAWING 1

Item	Qty	Nomenclature	Part No.
5	A/R	Sealant	
4	2	Cable Ties	2CDH-3
3	A/R	Ducting	2CDH-2
2	1	Flange	2CDH-1
1	1	Shroud	2CDH

S&M PRODUCTS
 2515 E. Bonnie Brook Lane
 Waukegan, IL 60087

Rev. 00 Date: 08-28-86

KIT NO. 11

View of Cooling Shroud on EDO-AIRE & SIGMA TEK Pumps, Ducting & Flange

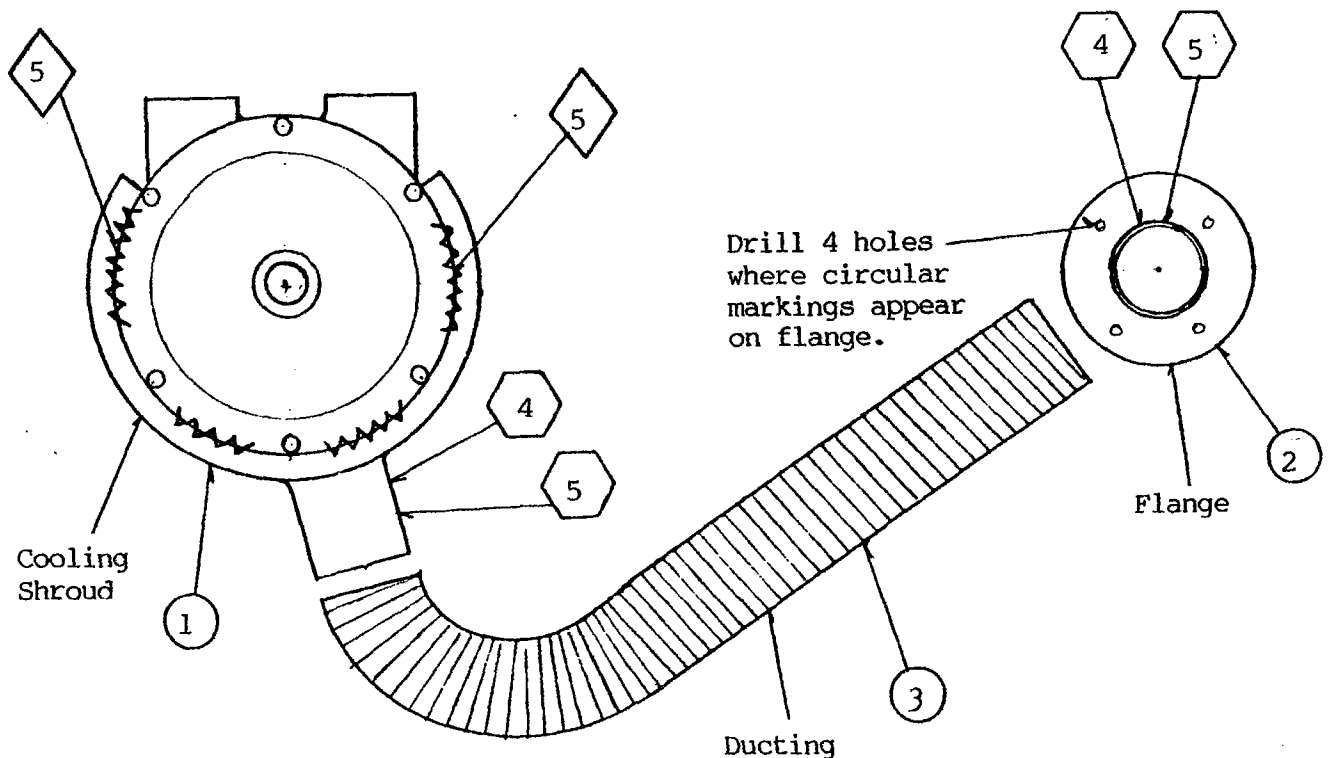

Note: Shroud must be centered on the pump. On some installations the pump may have to be rotated on the mounting pad because of interference with other objects.



Cable Ties - Attach these around ducting at inlet of shroud and outlet of flange after ducting has been sealed into place on the inlet and outlet.



Sealant - Place sealant on outside of shroud inlet and flange outlet, then push ducting into place. For type of sealant to be used, refer to paragraph 5b of Installation Instructions.



Apply sealant fillet between shroud and pump, at the rear of the pump, as shown, to prevent shifting of shroud on pump.

DRAWING 2

Item	Qty	Nomenclature	Part No.
5	A/R	Sealant	
4	2	Cable Ties	2CDH-3
3	A/R	Ducting	2CDH-2
2	1	Flange	2CDH-1
1	1	Shroud	4ADH

S&M PRODUCTS
 2515 E. Bonnie Brook Lane
 Waukegan, IL 60087

Rev. 00 Date: 08-28-86

KIT NO. 20

VIEW OF COOLING SHROUD ON AIRBORNE 400-SERIES PUMPS,
DUCTING & FLANGE

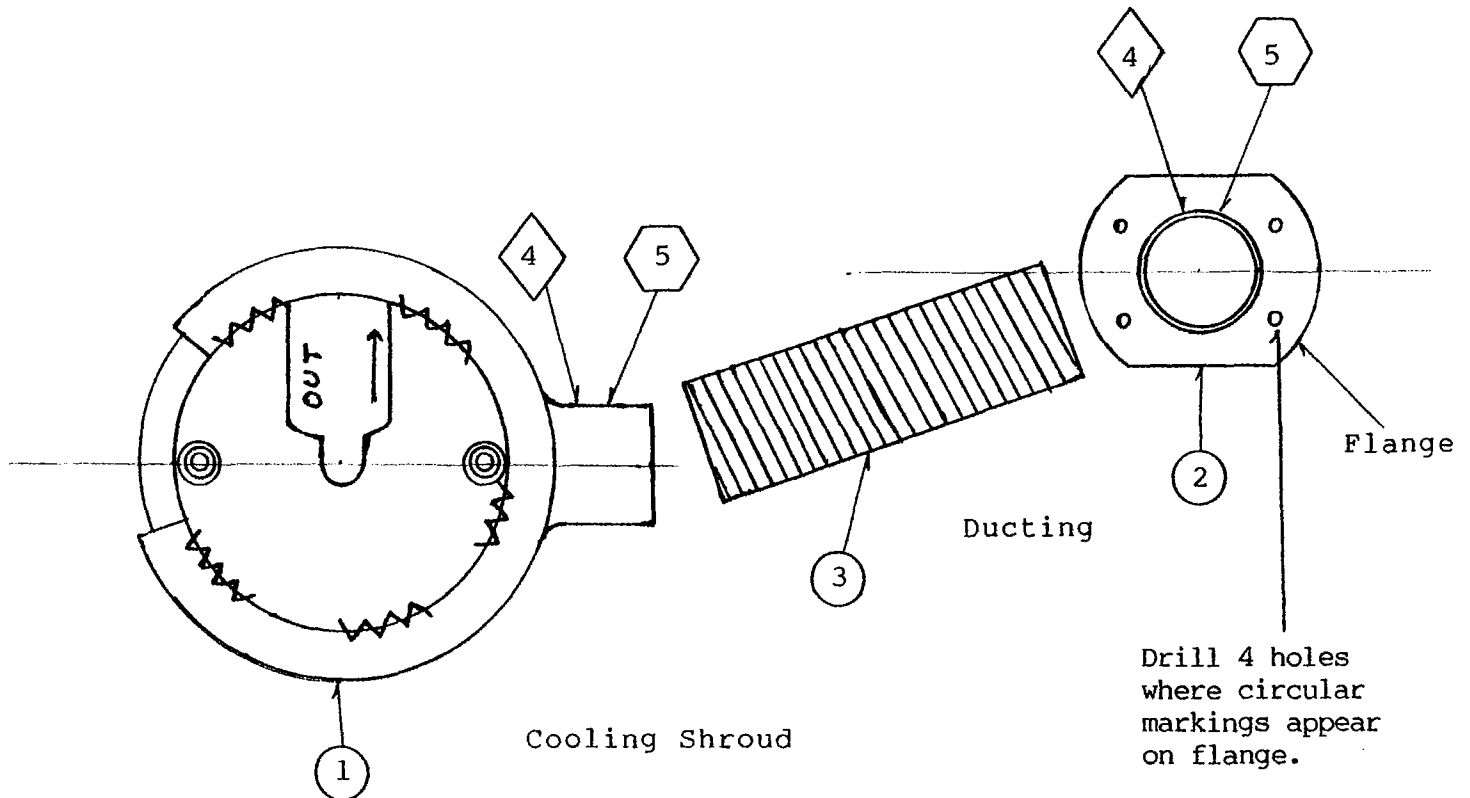

Note: Shroud must be centered on the pump.

4 Cable Ties - Attach these around ducting at inlet of shroud and outlet of flange after ducting has been sealed into place on the inlet and outlet.

5 Sealant - Place sealant on outside of shroud inlet and flange outlet, then push ducting into place. For type of sealant to be used, refer to paragraph 5b of Installation Instructions. Note: If cooling shroud appears to rotate easily after installation, it may be advisable to place a sealant fillet between shroud and pump as shown.

DRAWING 3

Item	Qty	Nomenclature	Part No
5	A/R	Sealant	
4	2	Cable Ties	2CDH-3
3	A/R	Ducting	6ADH-2
2	1	Flange	6ADH-1
1	1	Shroud	6ADH